

Enforce HS

Specification Sheet for Verivolt Anti-Aliasing Filter module

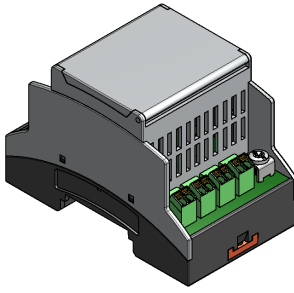

OVERVIEW

The Enforce HS series was designed to be an off the shelf anti-aliasing filter for generic applications. The Enforce family covers the ranges of 10kHz to 1MHz bandwidth with very low noise and 0.1% accuracy.

Each Enforce HS module outputs $\pm 10V$ filtered version of the the differential signals at the input. The output is a low impedance voltage signal that can then be processed by a computer based measurement system.

SPECIFICATION

Enforce HS	450kHz
Integrated sensor noise (Referenced to input)	< 100 μV
Gain (Using 10V standard output voltage)	1
Differential input dynamic range	20V
Input Impedance	> 1 G Ω

HARDWARE DESCRIPTION

Verivolt Enforce HS operates as an anti-aliasing filter with $\pm 10V$ input and output dynamic range.

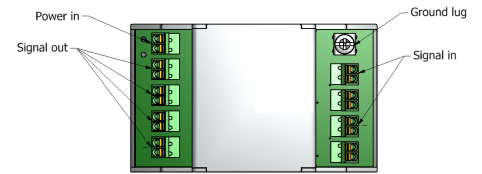

Connections for Enforce HS

There are 4 channels per module. The input and output signal to each channel is a differential pair, which interfaces to the outside world through a pair of spring cage connectors. For better signal integrity it is recommended to use twisted pairs when possible. The signal out of the sensor comes as a differential pair, with each line having 50-Ohm output impedance. This allows the Enforce HS to be used as a single-ended or differential source, connected to 50Ohm or high impedance inputs.

Electrical	
Accuracy (percentage of reading)	$\pm 0.1\%$
Max Input delay	<150ns
Mechanical	
Mounting Type	DIN Rail
Connectivity In	Spring cage
Connectivity Out	Spring cage
Outer Dimensions	3.6" x 2.4" x 1.4"
Weight	198 g (7.0 oz)

Performance	
Input-Output non-linearity	< 80 ppm
Output voltage	$\pm 10V$ ($\pm 5V$ Custom)
Gain temperature drift	± 40 ppm/ $^{\circ}C$
Offset temperature drift	$\pm 3\mu V$ / $^{\circ}C$
Common mode rejection at 60Hz	82 dB
Power Supply Voltage	+8V to +27V
Output type	Differential signal
Output Offset Voltage	< $\pm 500\mu V$ (on $\pm 10V$ signal)
Line output impedance	50 Ω
Environmental	
Operating temperature	- 25 to 70 $^{\circ}C$
Storage temperature	- 40 to 80 $^{\circ}C$

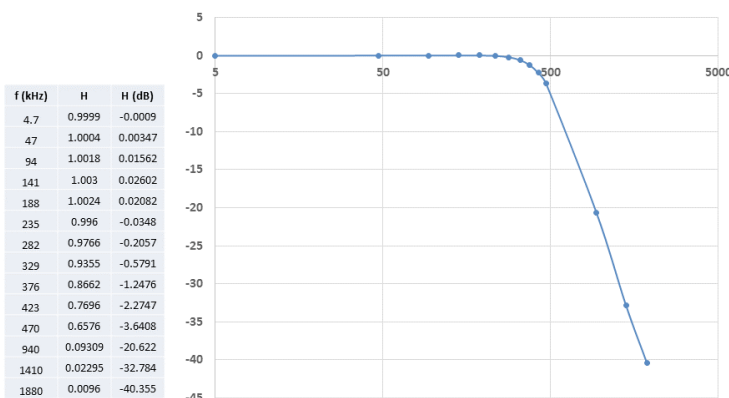

0.05% deviation at 50kHz, 0.5% deviation at 250kHz, -3dB at 450kHz, -22dB at 1MHz

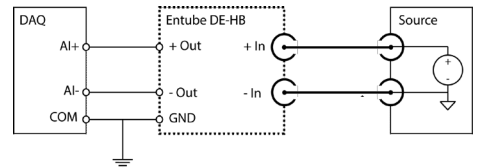

The schematic on the figure above shows how to connect the Enforce HS between the input signal source and the data acquisition.

MERCHICAL DIMENSIONS

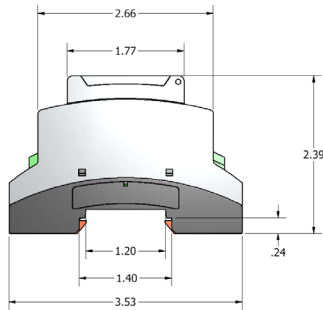
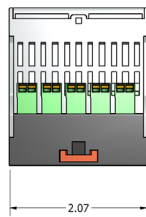
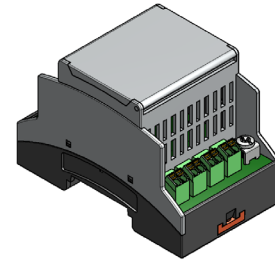
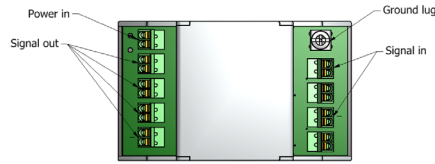
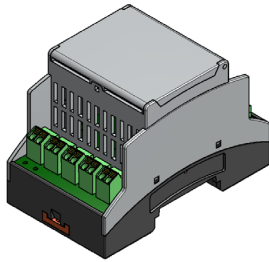

Ground lug
6/32 x 1/4L Screw
0.31" square surface
Brass, Nickel plate

HARDWARE CONFIGURATION

A. Ground sensor by connecting a wire from the ground to the standoff located next to the two spring connectors. Connect external power source to power the unit.

B. Insert a wire pair between each of these connectors and a corresponding current input on the DAQ. The polarity of the signal out is aligned with the input signals.

C. On the primary side, connect the plus and minus signals. Use standard twisted pair.

A

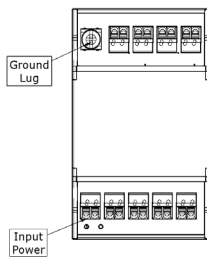

B

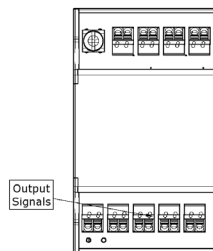

C

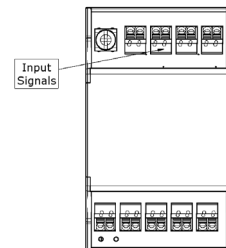

⚠ DANGER

THIS SENSOR IS NOT A SAFETY DEVICE AND IS NOT INTENDED TO BE USED AS A SAFETY DEVICE. This sensor is designed only to detect and read certain data in an electronic manner and perform no use apart from that, specifically no safety-related use. This sensor product does not include self-checking redundant circuitry, and the failure of this sensor product could cause either an energized or de-energized output condition, which could result in death, serious bodily injury, or property damage.